



RUBBER SUSPENSION ARM BUSH KIT

Installation Instructions

Part No. 839RK

To Suit Nissan GQ Patrol / Ford Maverick 1989+ - Short and Long Wheel Base

SAFETY ADVICE: It is recommended that the following procedure be conducted only by trained Ironman 4x4 staff or distributors. Warranty will be voided by damage or failure caused by incorrect procedure. Always wear personal safety protection ie. Safety glasses, gloves, ear protection if required.

When pressing out bushes with an outer steel housing make sure that the outer housing is utilised when pressing out the bush. Never press on the centre of the bush as this will damage the bush.

Kit Contains:

- 4 x 832RT front radius arm bushes
- 8 x 836RT rear trailing arm bushes
- 4 x 833R front radius arm bushes to chassis
- 2 x 840RT front and rear panhard arm bushes
- 2 x 834RT front and rear panhard arm bushes

Front Panhard Rod:

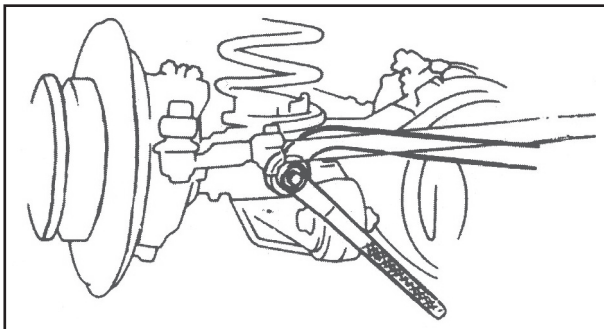

Removal:

1. Jack up the front axle housing and support it with jack stands.
2. Disconnect panhard rod from front axle housing.
3. Disconnect panhard rod from chassis and remove.
4. Replace both bushes using a press.
NOTE: When inserting and removing the bushing, press or pull on the metal surface.

Installation:

1. Re-install panhard rod.
NOTE: Support the chassis on jack stands and use a jack to control differential height to aid in panhard rod fitment.
2. Neutralise suspension.
 - A. Lower the vehicle.
 - B. Bounce the vehicle up and down to neutralise the suspension.

Torque nuts and bolts to (72 ft-lb, 98 Nm)

Tools & Equipment

- 17, 19, 22 and 24mm spanner or socket
- Ratchet
- Suitable press tools
- Hydraulic press
- Jack stands x 2, jack or hoist
- Hammer
- Pry bar

Front Radius Arm:

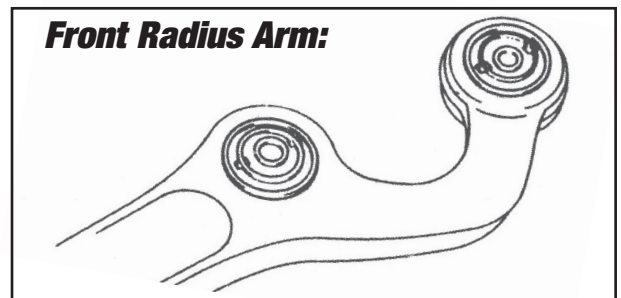

Removal:

1. Jack up the vehicle and support it with jack stands.
2. Remove the two front bolts, and rear nut, remove radius arm from vehicle.

Replacement of radius arm bushing:

1. Press out the bushings from the radius arm.
2. Press new bushings into the radius arm. Ensure voids are positioned horizontally as shown above.

Installation:

1. Install radius arm to chassis.
2. Install the arm to the front axle housing with the 2 bolts.
3. Remove the stands, lower the vehicle to the ground and rock the vehicle up and down to neutralise the suspension.
4. Torque nuts and bolts to (181 ft-lb, 245 Nm)



RUBBER SUSPENSION ARM BUSH KIT

Installation Instructions

Part No. 839RK

Fitting Instructions for Front Suspension:

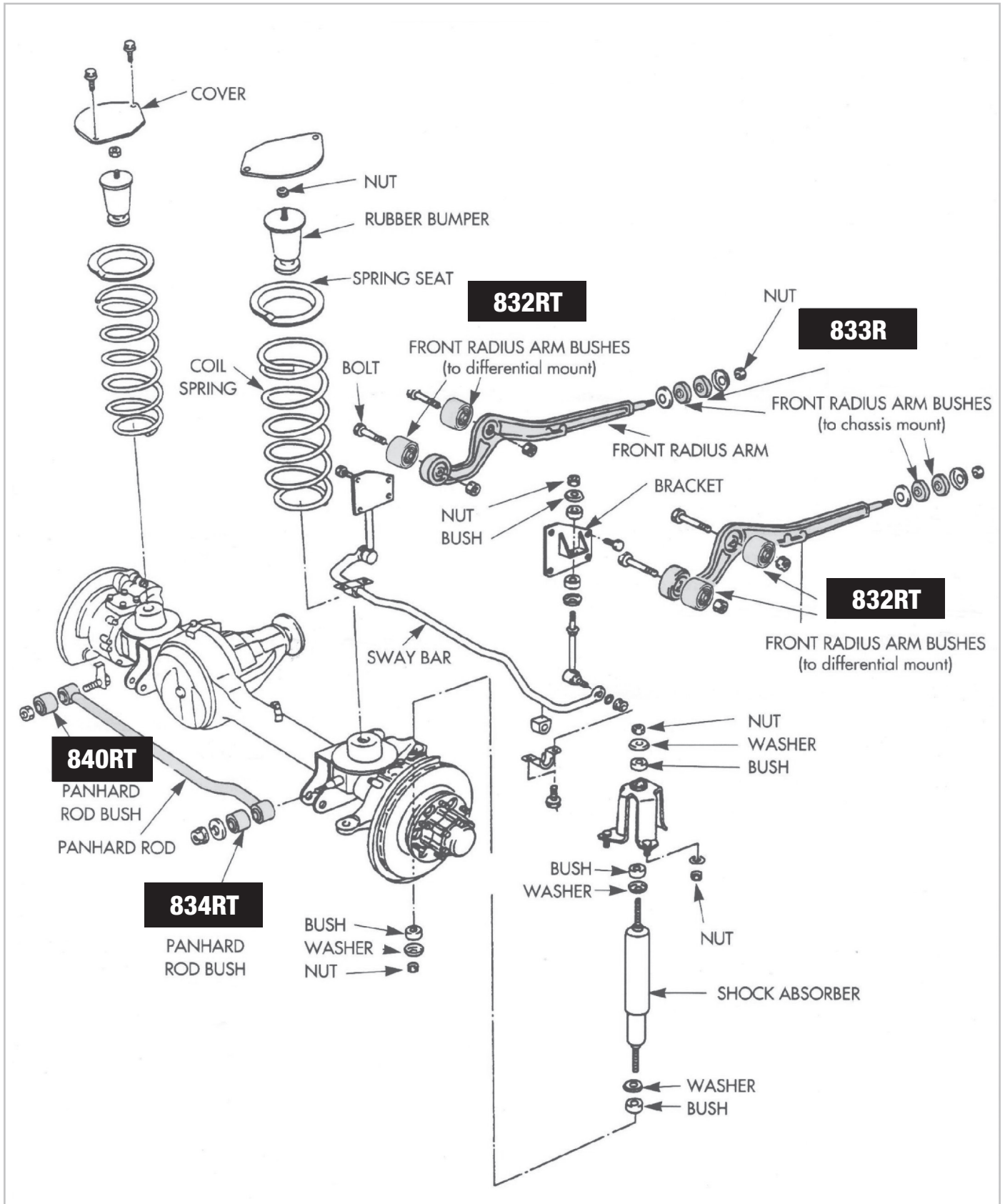

Fitting Instructions for Rear Suspension:

Upper and Lower Trailing Arm:

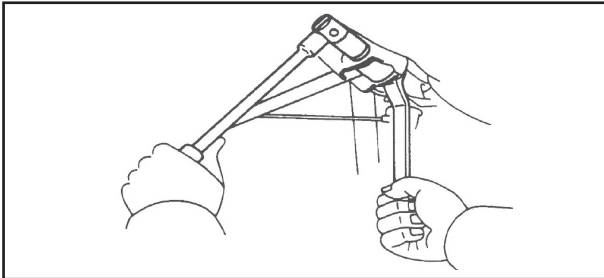

Removal:

- 1.** Jack up and safely support vehicle on the chassis. Support the rear differential housing with a jack.
- 2.** Remove one upper trailing arm.
- 3.** Remove one lower trailing arm.
- 4.** Replace trailing arm bushes.
Ensure voids are positioned horizontally.

Installation:

- 1.** Install the upper trailing arm.
NOTE: Insert the bolt from the outside of the vehicle and leave bolt loose.
- 2.** Install the lower trailing arm.
NOTE: Insert the bolt from the outside of the vehicle and leave bolt loose.
- 3.** Neutralise suspension.
A. Lower the vehicle.
B. Bounce the vehicle up and down to neutralise the suspension.
- 4.** Torque all trailing arm fasteners to (130 ft-lb, 177 Nm)
- 5.** Carry out bush replacement on other two trailing arms as per steps 1 - 4.

Rear Panhard Rod:

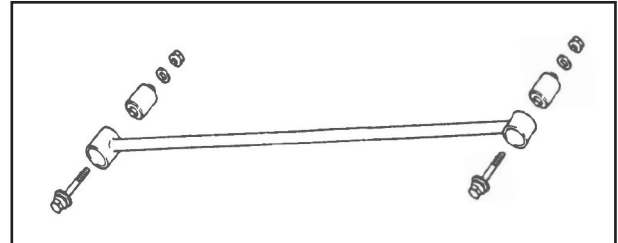

Removal:

- 1.** Jack up the rear axle housing and support it with jack stands.
- 2.** Disconnect panhard rod from rear axle housing.
- 3.** Disconnect panhard rod from chassis and remove.
- 4.** Replace both bushes using a press.
NOTE: When inserting and removing the bushing, press or pull on the metal surface.

Installation:

- 1.** Re-install panhard rod.
NOTE: Support the chassis on jack stands and use a jack to control differential height to aid in panhard rod fitment.
- 2.** Neutralise suspension.
A. Lower the vehicle.
B. Bounce the vehicle up and down to neutralise the suspension.

Torque nuts and bolts to (72 ft-lb, 98 Nm)



RUBBER SUSPENSION ARM BUSH KIT

Installation Instructions

Part No. 839RK

Fitting Instructions for Rear Suspension:

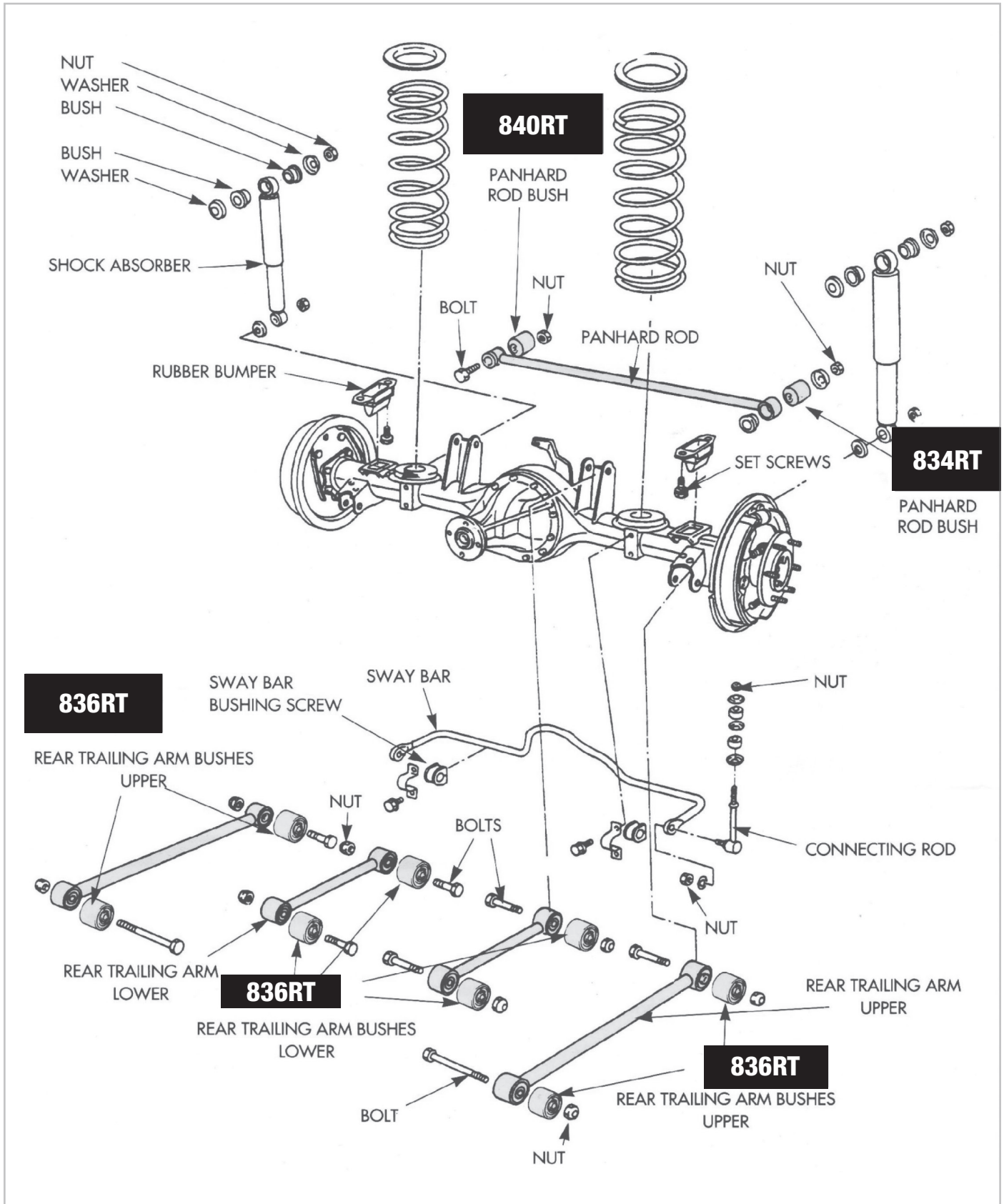



**FRONT RADIUS ARM
BUSHES TO DIFF MOUNT
PART NO. 832RT
4 PER VEHICLE**

**839RK - TO SUIT NISSAN GQ PATROL
FORD MAVERICK 1989+**

**FRONT RADIUS ARM BUSHES TO CHASSIS MOUNT
PART NO. 833R 4 PER VEHICLE**

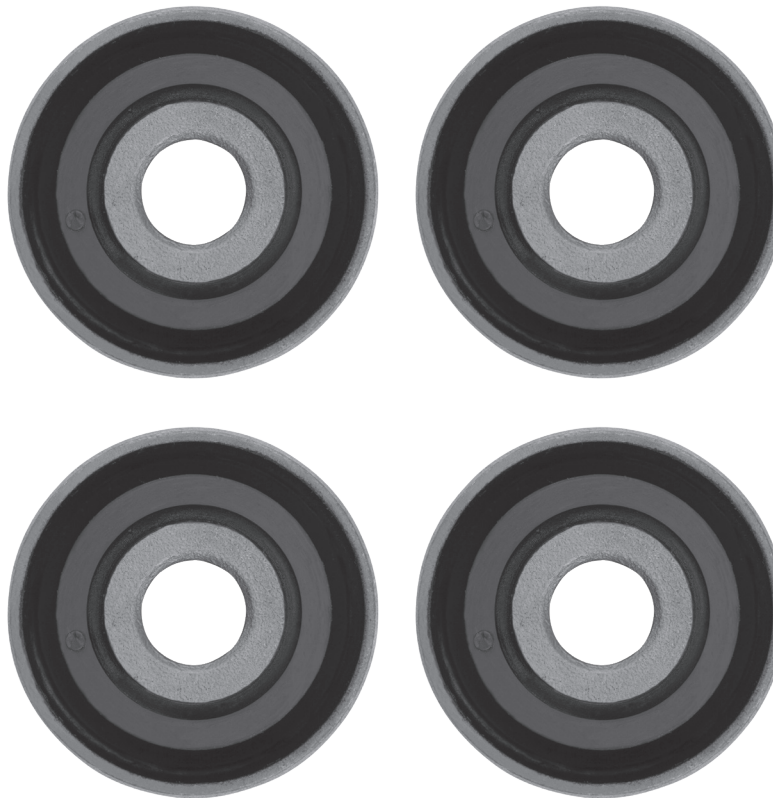
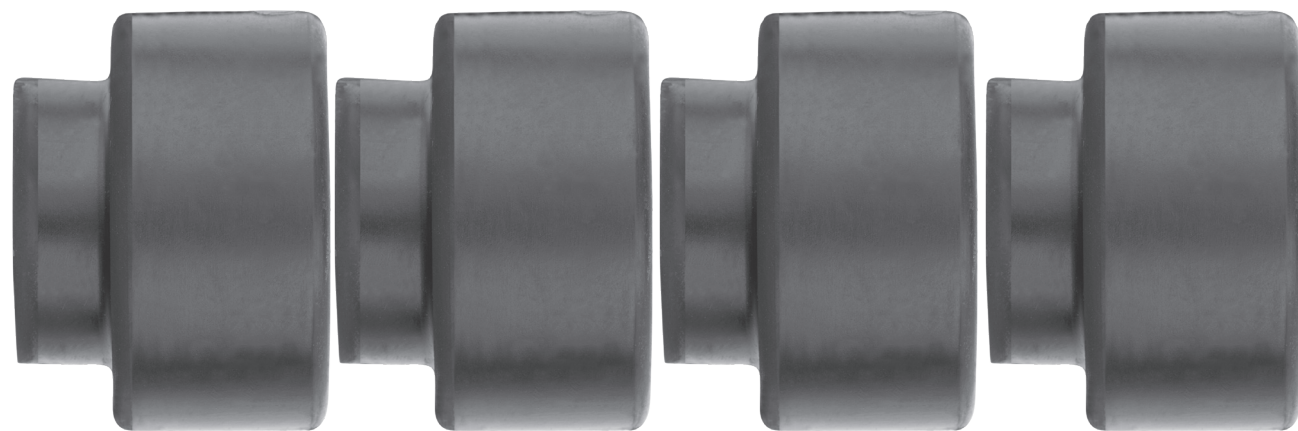

**REAR TRAILING ARM
BUSHES
PART NO. 836RT
8 PER VEHICLE**

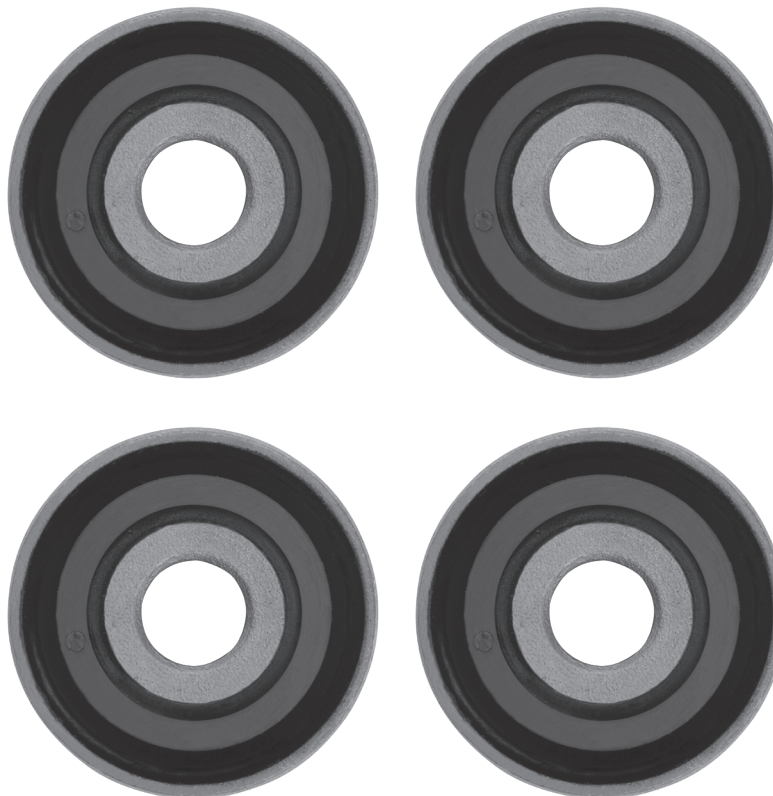

**FRONT PANHARD
ROD BUSH
PART NO. 834RT
1 PER VEHICLE**



**FRONT PANHARD
ROD BUSH
PART NO. 840RT
1 PER VEHICLE**

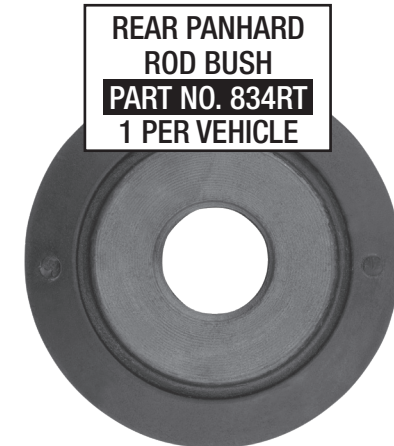

**REAR PANHARD
ROD BUSH
PART NO. 834RT
1 PER VEHICLE**



**REAR PANHARD
ROD BUSH
PART NO. 840RT
1 PER VEHICLE**